

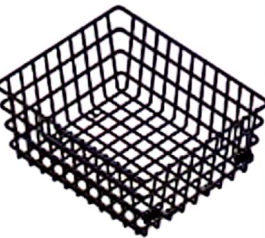

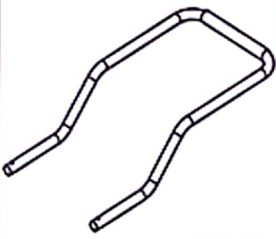









<p>①  X 2 PCS</p>	<p>③  X 1 PC</p>	<p>④  X 1 PC</p>	<p>⑤  X 2 PCS</p>	<p>A  M6 X 10 4 PCS</p>	<p>C1  M6 X 30 10 PCS</p>	<p>C2  M X 35 8 PCS</p>	
<p>②  X 4 PC</p>			<p>⑥  X 2 PCS</p>	<p>B  Ø6 4 PCS</p>	<p>D  Nut 8 PCS</p>		

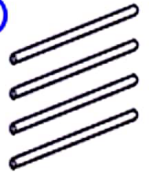

 TIGHTEN 1 AND 2 WITH C2  
APRIETE 1 Y 2 CON C2  
SERREZ 1 ET 2 AVEC C2

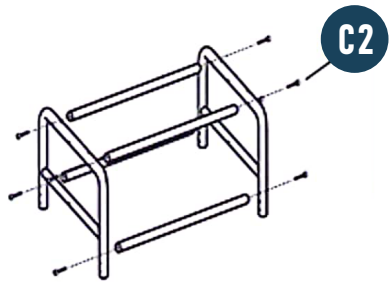
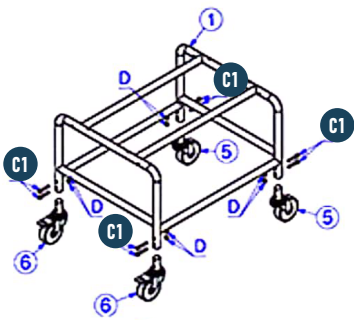
**STEP 1**



 TIGHTEN 1, 5 AND 6 WITH C1  
APRIETE 1, 5 Y 6 CON C1  
SERREZ 1, 5 ET 6 AVEC C1

**STEP 2**

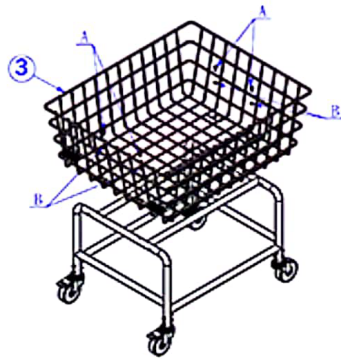

 TIGHTEN 3 AND PARTS A AND B  
APRIETE 3 Y LAS PIEZAS A Y B  
SERREZ 3 ET LES PIÈCES A ET B

**STEP 3**



 INSERT 4 FROM THE FIRST GRID OF THE BASKET, POSITION IT VERTICALLY  
AND ALIGN WITH THE HOLE AND TIGHTEN IT WITH C1  
INSÈRE 4 DE LA PRIMERA REJILLA DE LA CESTA, COLÓQUELO VERTICALMENTE  
Y ALINÉELO CON EL ORIFICIO Y APRIÉTELO CON C1  
INSÉREZ 4 DEPUIS LA PREMIÈRE GRILLE DU PANIER,  
POSITIONNEZ-LE VERTICALEMENT ET ALIGNEZ-LE AVEC LE TROU ET SERREZ-LE AVEC C1

**STEP 4**